

EXPLODED VIEW & PARTS LISTING

Air Operated Double Diaphragm Pump

Model: DP-15FDT

Model# 853867

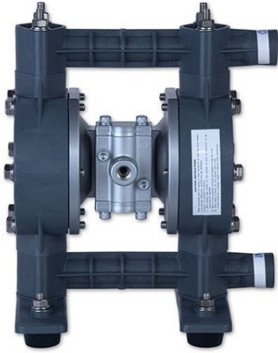

To Purchase:

☎ 800-990-7867

✉ sales@yamadapump.com

📍 Find My Rep

More Information:

▶ YouTube: @yamadapump

🌐 yamadapump.com

Data Sheets | CAD Drawings | Manuals
Literature | BOM | Performance Curves

Trial Program

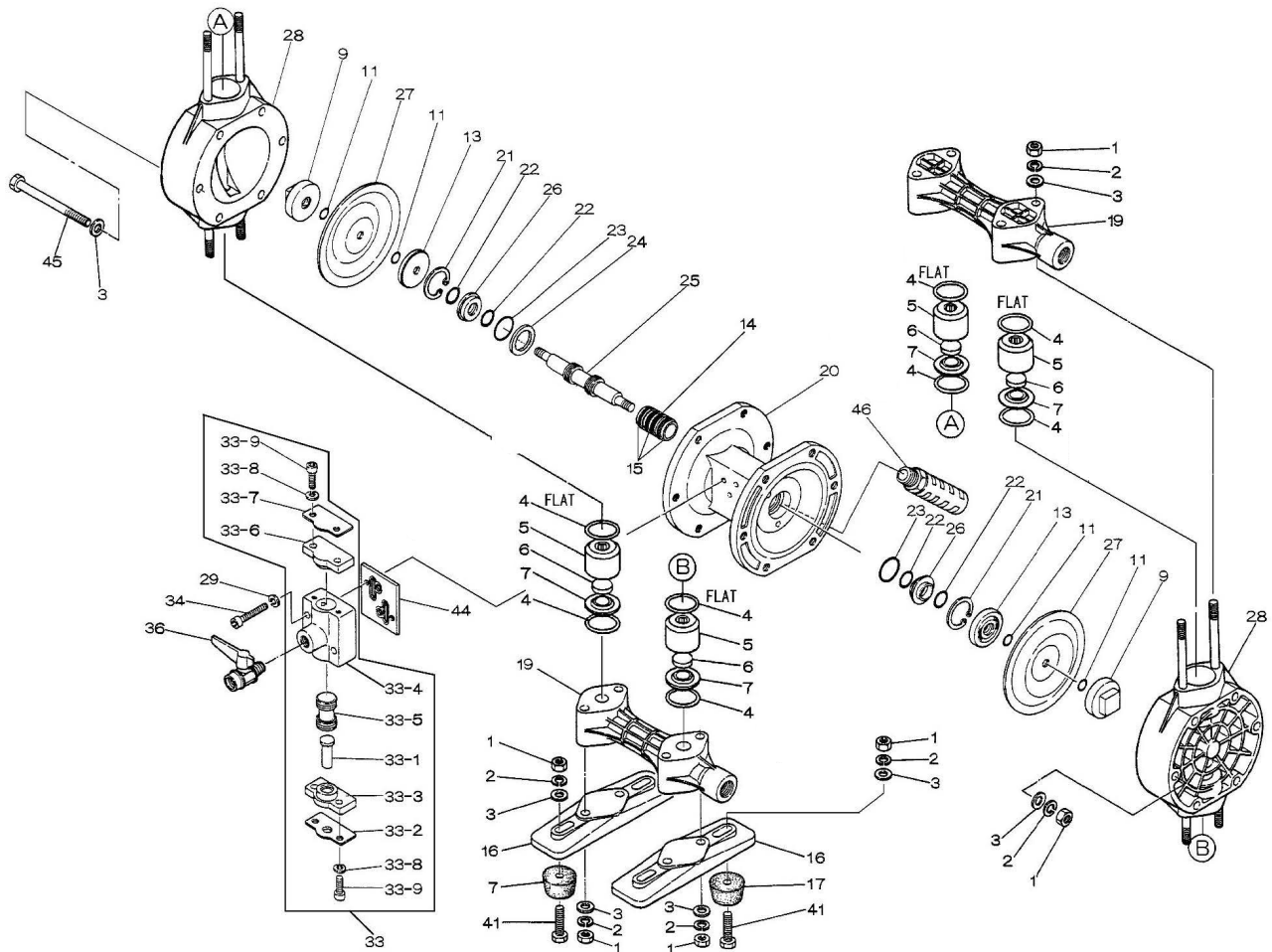

Air Operated Double Diaphragm Pump

| REF. No. | PARTS No. | DESCRIPTION | QTY. | REORDER |
|----------|-----------|--------------------------|------|---------|
| 1 | 628012 | NUT | 12 | |
| 2 | 681300 | SPRING LOCK WASHER | 24 | |
| 3 | 631329 | PLAIN WASHER | 24 | |
| 4 | 643027 | O-RING | 8 | |
| 5 | 772718 | VALVE STOPPER | 4 | |
| 6 | 771340 | FLAT VALVE | 4 | |
| 7 | 772719 | VALVE SEAT | 4 | |
| 9 | 772722 | CENTER DISK | 2 | |
| 11 | 643005 | O-RING | 4 | |
| 13 | 770968 | CENTER DISK | 2 | |
| 14 | 714678 | SLEEVE | 1 | |
| 15 | 684900 | O-RING | 4 | |
| 16 | 772720 | BASE | 2 | |
| 17 | 770551 | CUSHION | 4 | |
| 19 | 780202 | MANIFOLD | 2 | |
| 20 | 715107 | BODY | 1 | |
| 21 | 630807 | RETAINING RING C TYPE | 2 | |
| 22 | 684284 | PACKING | 4 | |
| 23 | 640131 | O-RING | 2 | |
| 24 | 772651 | SPACER | 1 | |
| 25 | 801785 | CENTER ROD ASSEMBLY | 1 | |
| 26 | 772619 | GUIDE BUSHING | 2 | |
| 27 | 770933 | DIAPHRAGM | 2 | |
| 28 | 780199 | OUT CHAMBER | 2 | |
| 29 | 681855 | SPRING LOCK WASHER | 2 | |
| 33 | 804505 | VALVE BODY ASSEMBLY | 1 | |
| 33-1 | 706798 | PUSH ROD | 1 | |
| 33-2 | 710587 | REINFORCEMENT PLATE A | 1 | |
| 33-3 | 771357 | CAP | 1 | |
| 33-4 | 710853 | SPOOL VALVE CASE | 1 | |
| 33-5 | 801404 | SPOOL VALVE ASSEMBLY | 1 | |
| 33-6 | 771356 | CAP | 1 | |
| 33-7 | 710636 | REINFORCEMENT PLATE B | 1 | |
| 33-8 | 681855 | SPRING LOCK WASHER | 4 | |
| 33-9 | 682943 | HEXAGON SOCKET HEAD BOLT | 4 | |
| 34 | 682918 | HEXAGON SOCKET HEAD BOLT | 2 | |
| 36 | 683055 | BALL VALVE | 1 | |
| 41 | 621153 | BOLT | 4 | |
| 44 | 771358 | GASKET | 1 | |
| 45 | 621160 | BOLT | 12 | |
| 46 | 682520 | SILENCER | 1 | |
| KIT | K15-DT | LIQUID SIDE | | |
| KIT | K115-AM | AIR MOTOR | | |

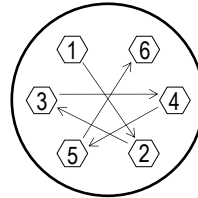

Tightening torque for center rod and out chambers.

Center Rod 122 in-lbf {14 N-m}
Out Chambers 105 in-lbf {12 N-m}

Tightening torque for manifold retainer bolts.

FDT 105 in-lbf {12 N-m}

General Tools:

- Socket wrench - 13mm
- Hexagonal box wrenches - 5mm
- Open-end wrench - 21mm
- Snap ring pliers

Miscellaneous:

- Assembly Oil—turbine oil none additional class 1 (equivalent to ISA VGA32 grade)
- Urea grease grade (NLGI) No. 2

Customer Notes

Model #: _____
Description: _____
Serial #: _____
Date Installed: _____
Department Location: _____
Tag/Project: _____