

Pulsation Dampener



To Purchase:

- 800-990-7867
- sales@yamadapump.com
- Find My Rep

More Information:

- YouTube: @yamadapump
- yamadapump.com
- Data Sheets | CAD Drawings | Manuals Literature | BOM | Performance Curves

Trial Program



REF. NO.	PART NO.	DESCRIPTION	QTY.	REORDER
1	713310	AIR CHAMBER	1	
2	771316	CUSHION	1	
4	711904	CENTER DISK	1	
5	771976	DIAPHRAGM	1	
6	621213	BOLT	6	
7	631331	PLAIN WASHER	6	
8	680607	SPRING WASHER	6	
9	628014	NUT	6	
10	772221	FLANGE OUT	1	
11	684122	O RING	2	
12	795081	VALVE	1	
13	716408	VALVE SEAT	1	
14	802569	MUFFLER	1	
16	630241	EYE NUT	1	
17	640017	O RING	1	
18	710717	NUT	1	
19	710719	NUT	1	

REF. NO.	PART NO.	DESCRIPTION	QTY.	REORDER
20	681170	MUFFLER	1	
21	714085	UNION	1	
22	710762	SPRING	1	
23	713443	CENTER ROD	1	
24	773092	THROAT BEARING	1	
25	630807	RETAINING RING	1	
26	772220	FLANGE IN	1	
27	713243	STUD	4	
28	631330	PLAIN WASHER	16	
29	680257	SPRING WASHER	8	
30	683542	BOLT	8	
33	771727	CENTER DISK	1	
34	780148	OUT CHAMBER	1	
35	628013	NUT	4	
36	771786	PROTECTOR A	4	
37	771787	PROTECTOR B	4	
38	771788	PROTECTOR C	4	

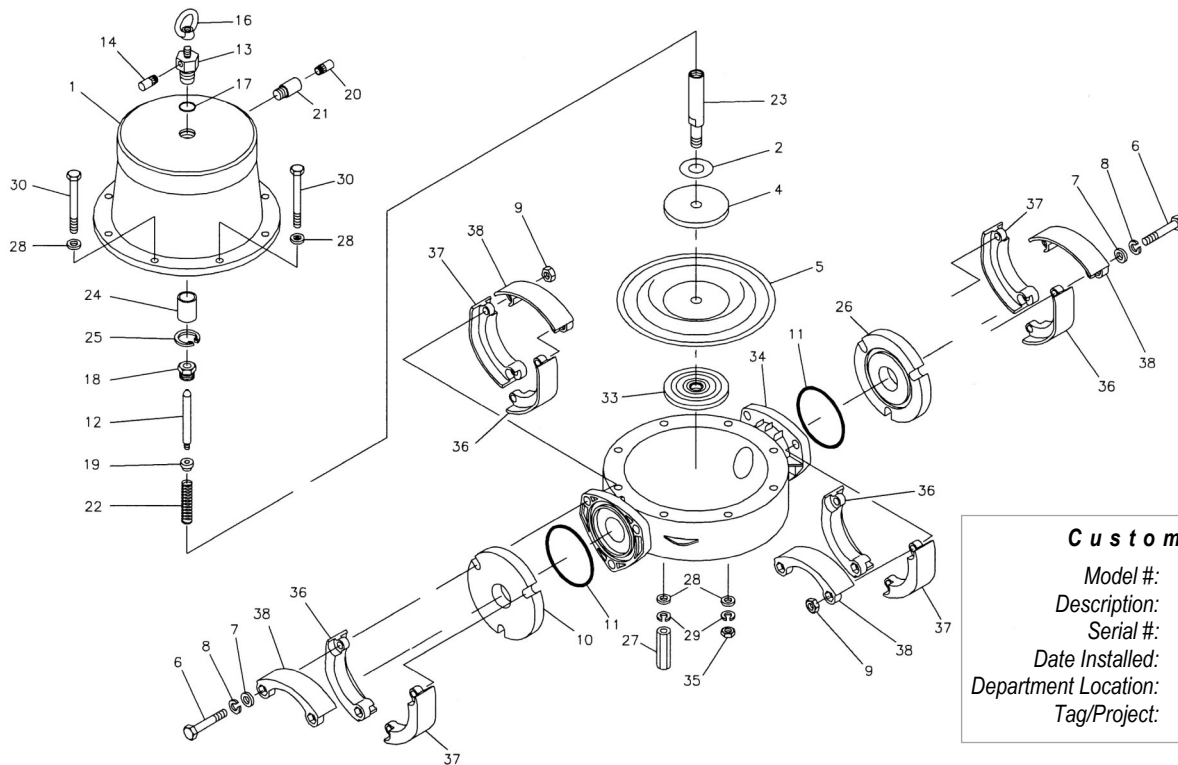

Customer Notes

Model #: _____

Description: _____

Serial #: _____

Date Installed: _____

Department Location: _____

Tag/Project: _____