

Pulsation Dampener



To Purchase:

- 800-990-7867
- sales@yamadapump.com
- Find My Rep

More Information:

- YouTube: @yamadapump
- yamadapump.com
- Data Sheets | CAD Drawings | Manuals Literature | BOM | Performance Curves

Trial Program



REF. NO.	PART NO.	DESCRIPTION	QTY.	REORDER
1	710675	AIR CHAMBER	1	
2	771316	CUSHION	1	
3	709151	CENTER DISK	1	
4	771974	DIAPHRAGM	1	
5	611177	BOLT	6	
7	631917	WAVE WASHER	10	
8	714090	FLANGE	2	
9	683997	O RING	2	
10	711703	BALL GUIDE	2	
11	590087	VALVE SEAT	2	
12	795079	VALVE	1	
13	716451	VALVE SEAT	1	
14	802569	MUFFLER	1	
16	640017	O RING	1	
17	710717	NUT	1	

REF. NO.	PART NO.	DESCRIPTION	QTY.	REORDER
18	710719	NUT	1	
19	681170	MUFFLER	1	
20	714085	UNION	1	
21	710720	SPRING	1	
22	710718	CENTER ROD	1	
23	773092	THROAT BEARING	1	
24	630807	RETAINING RING	1	
25	709150	WASHER	1	
26	710735	STUD	4	
28	682263	NUT	1	
29	682730	CONED DISC SPRING	1	
30	711695	OUT CHAMBER	1	
31	716258	CENTER DISK	1	
32	716259	WASHER	1	

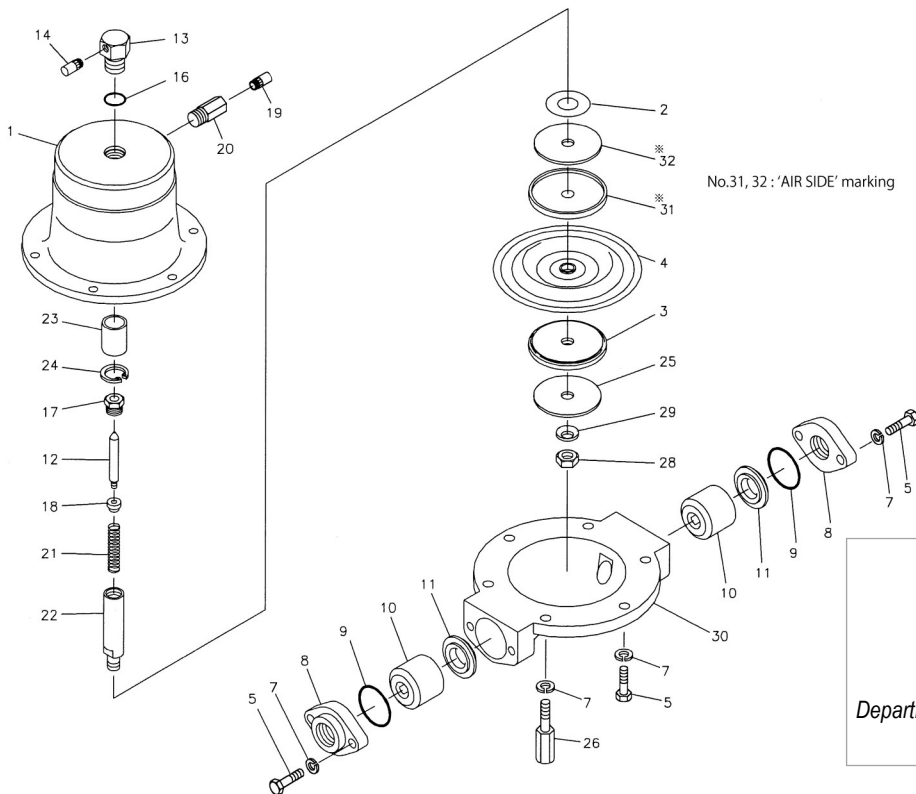

**Customer Notes**

Model #: \_\_\_\_\_

Description: \_\_\_\_\_

Serial #: \_\_\_\_\_

Date Installed: \_\_\_\_\_

Department Location: \_\_\_\_\_

Tag/Project: \_\_\_\_\_